

SNAP LOCK

Small Coop Run

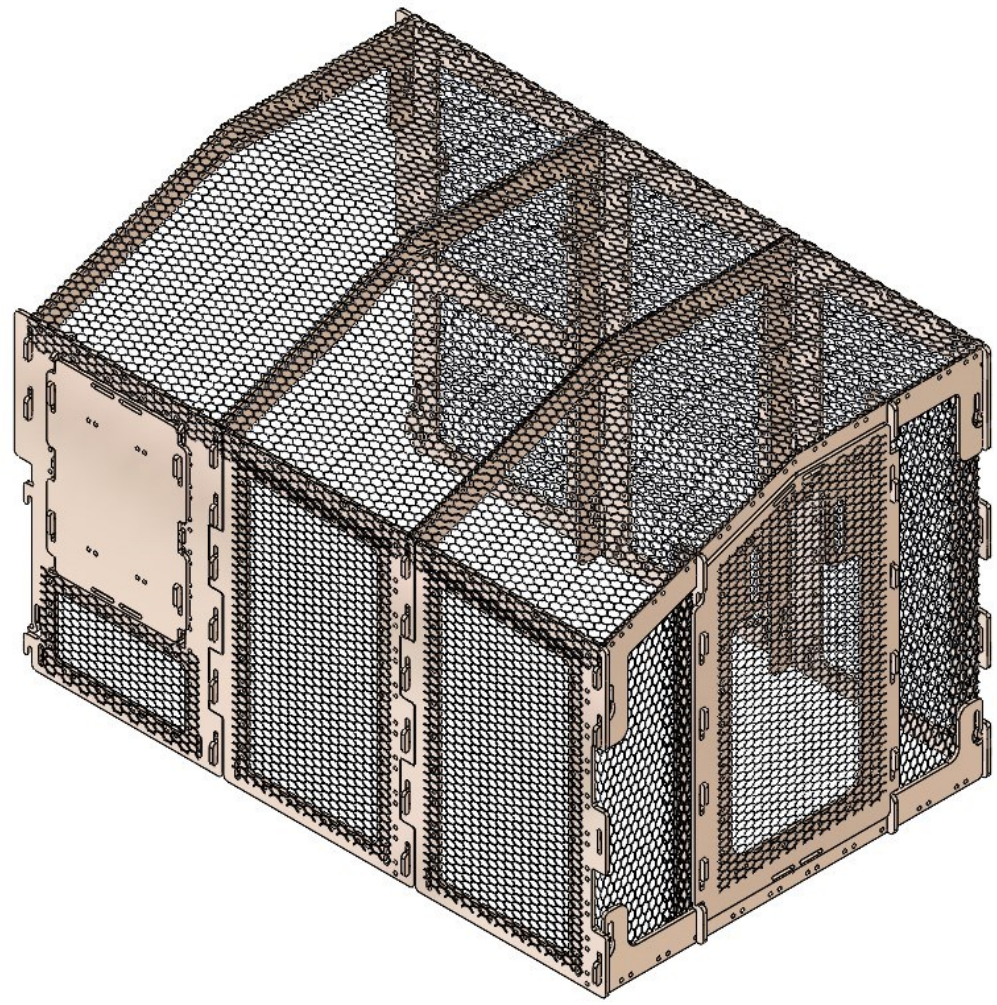

Instruction Manual
for Snap Lock Small Chicken Coop Run

PARTS LIST FOR THE SMALL SNAP LOCK CHICKEN COOP RUN

This kit for the Small Model SNAP LOCK CHICKEN COOP RUN includes the following:

- one envelope containing instructions, the warranty
- It also includes all the parts listed on this page

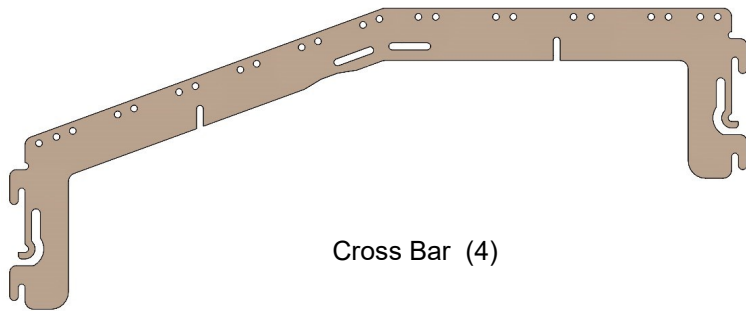

Cross Bar (4)

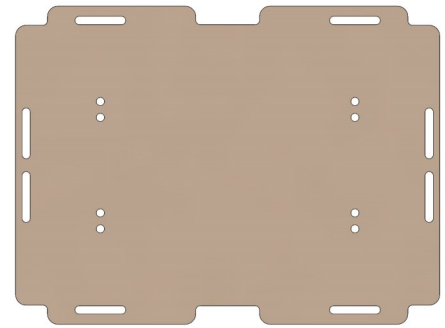

Side Door (1)

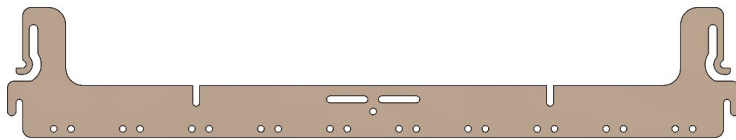

Lower Bar (1)



Side Door Frame (2)

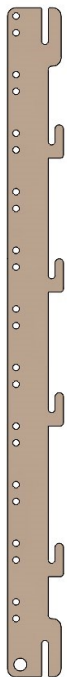

Door Frame 1 (1)

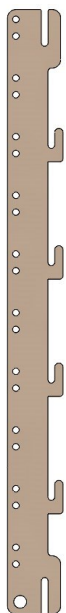

Door Frame 2 (1)

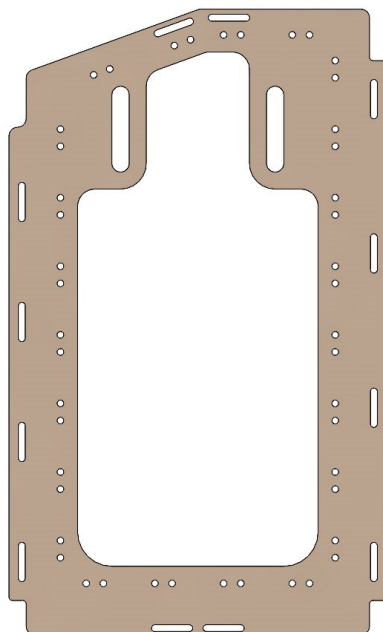

Door (1)



Link Bar 1 (2)

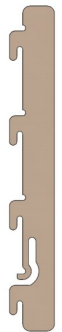

Link Bar 2 (2)

**PARTS LIST FOR THE SMALL SNAP LOCK CHICKEN COOP RUN
(CONTINUED)**

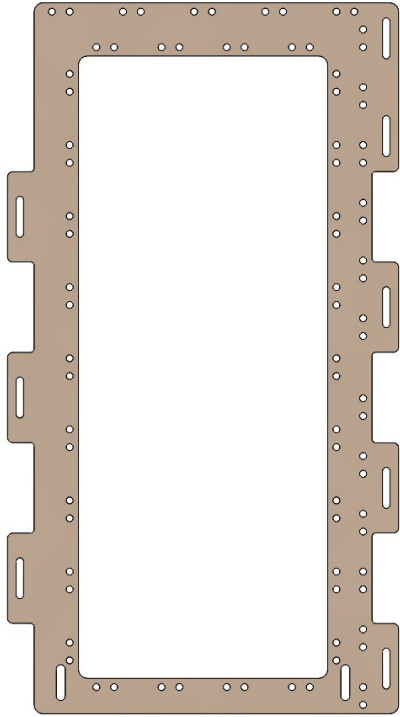

Side Panel 1 (2)

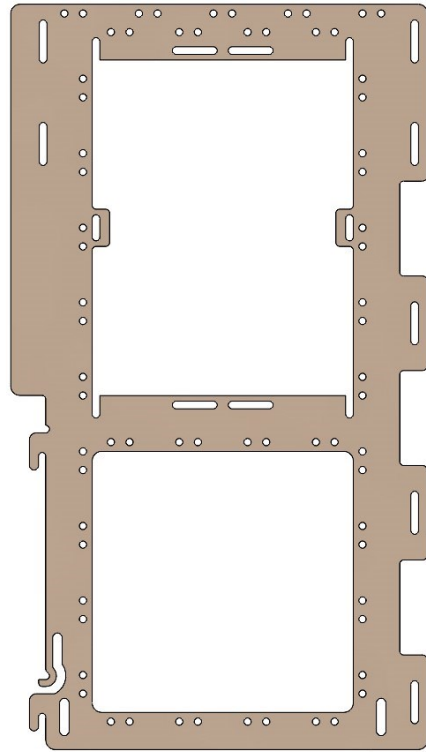

Side Panel 2 (1)

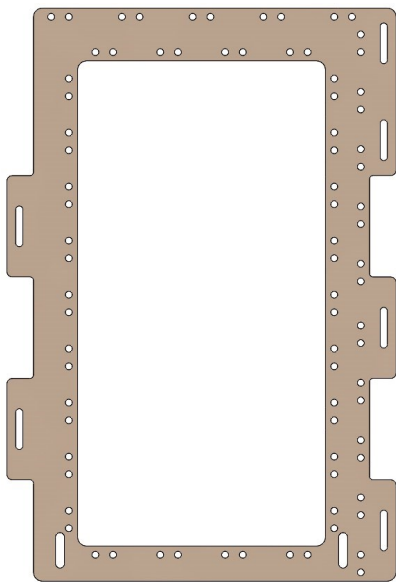

Side Panel 3 (2)

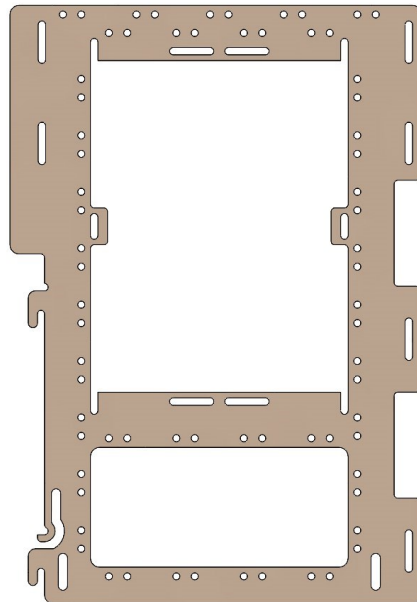

Side Panel 4 (1)

Exploded Views with Part Descriptions

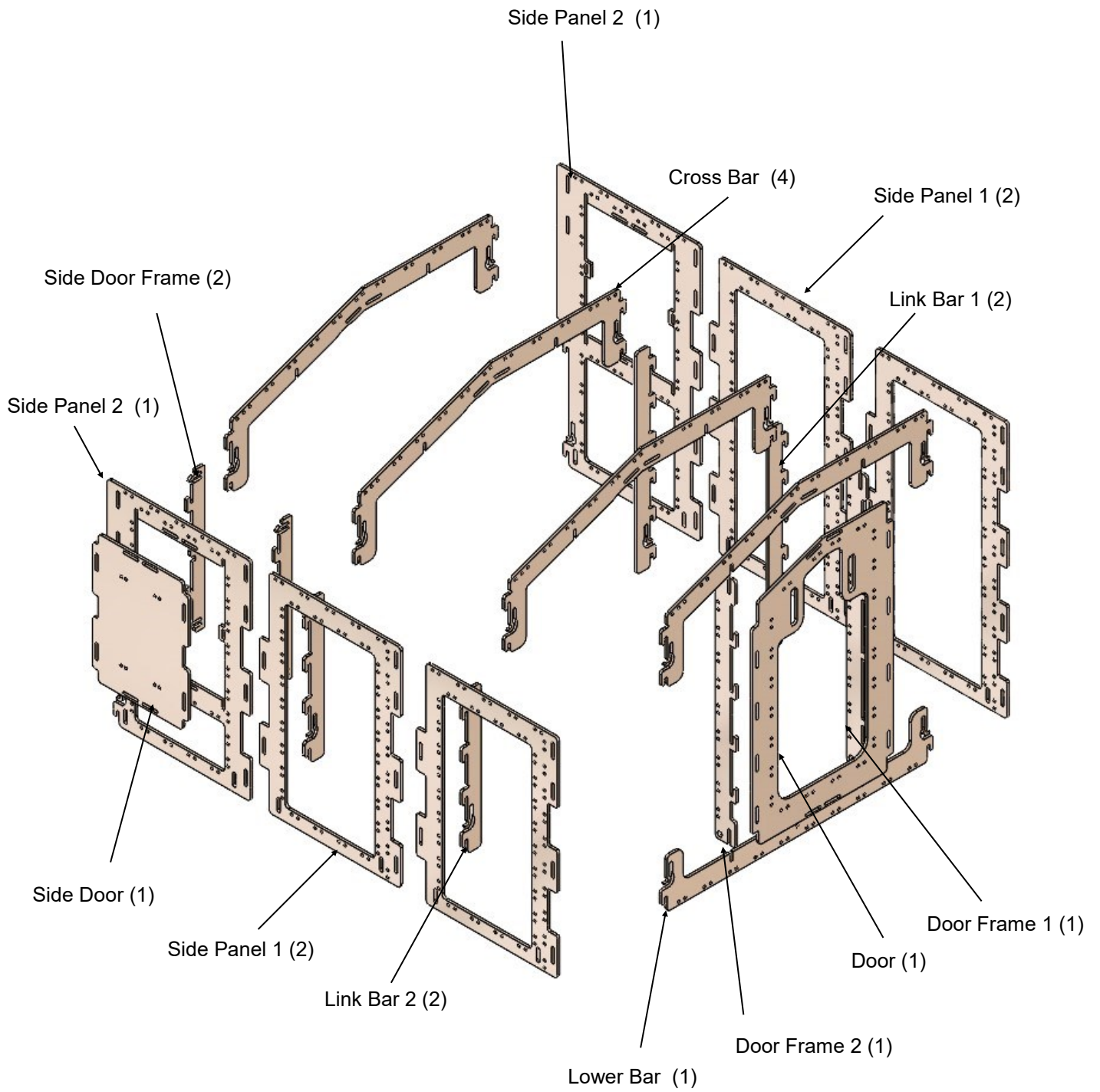

SMALL COOP RUN Assembly

Step 1: Place one side panel 1 next to one side panel 2. Press the panels together to interlock the profiles. Insert a link bar 1 into the aligned slots, avoiding the top two slots on the side panel 2. Press the linking bar down firmly until it clicks into place.

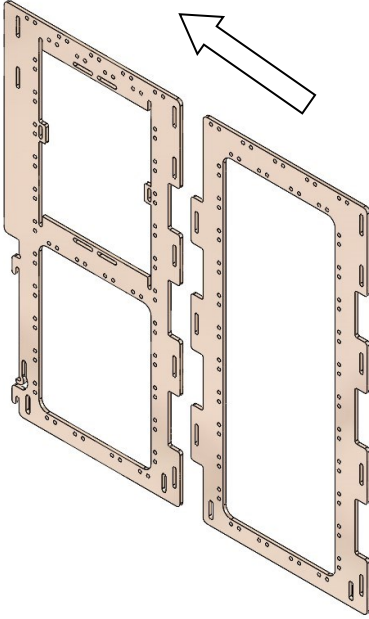

Fig. 1a

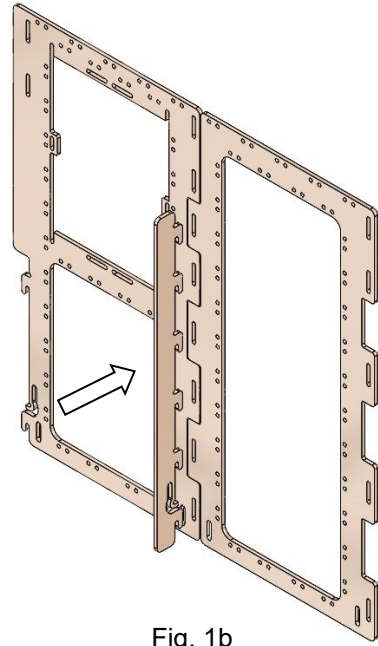

Fig. 1b

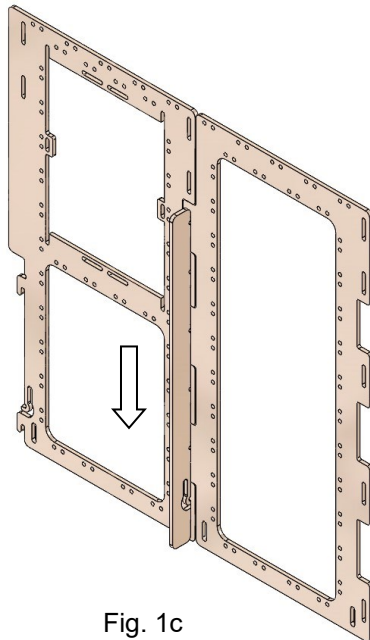

Fig. 1c

SMALL COOP RUN Assembly

Step 2: Add a second side panel 1 to the assembly, once again matching the profiles and using a linking bar to connect the panel sections.

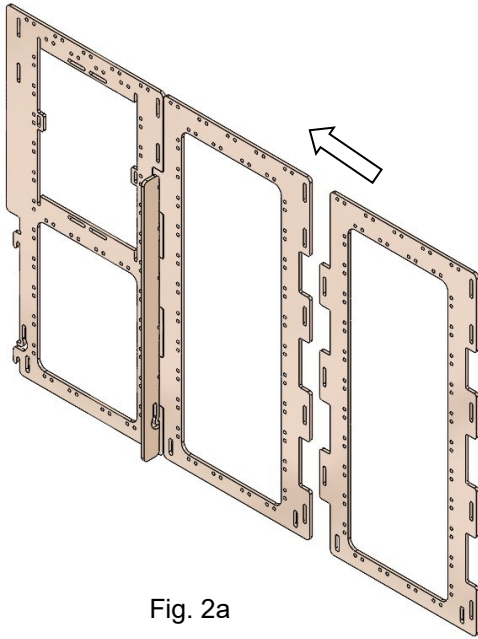

Fig. 2a

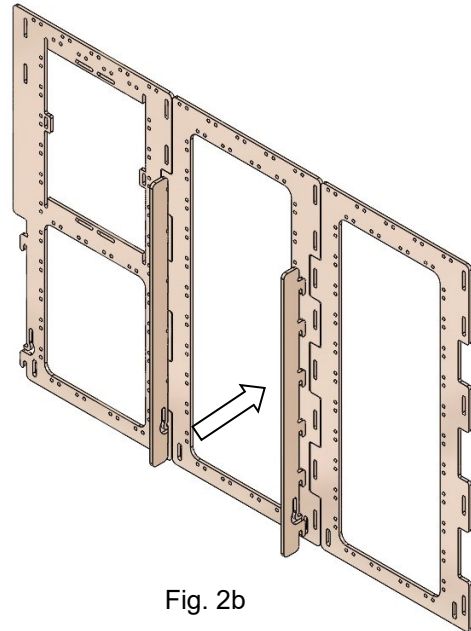

Fig. 2b

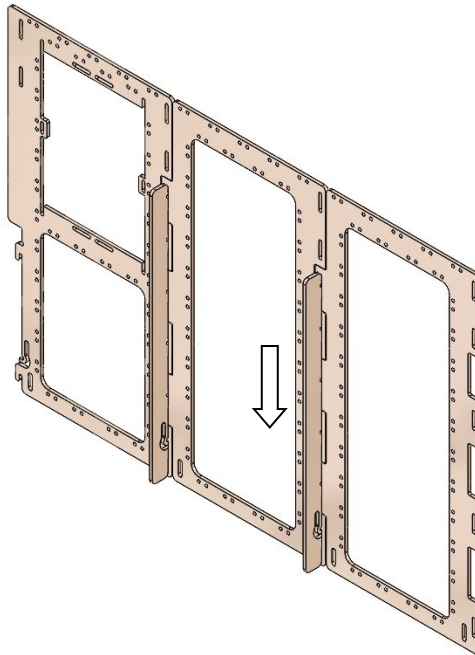
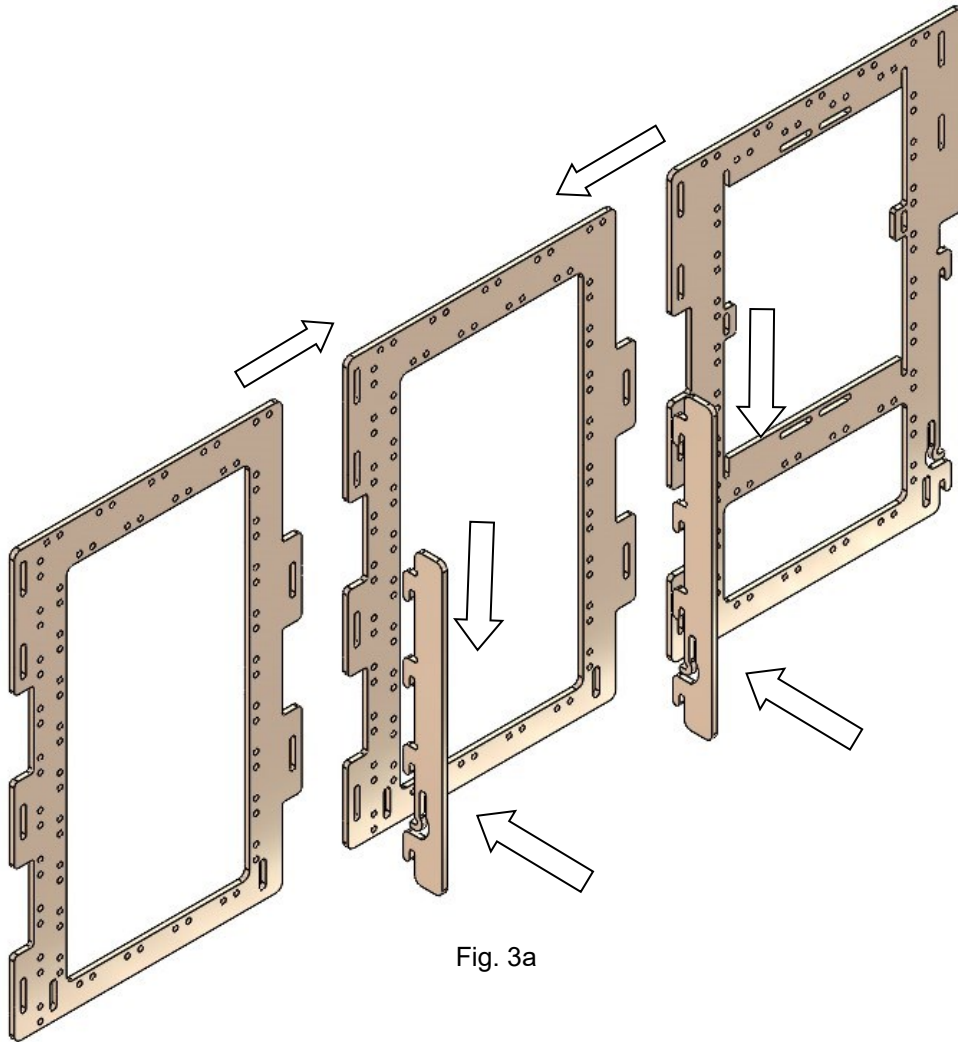

Fig. 2c

SMALL COOP RUN Assembly

Step 3: Repeat step 1 and 2 with but using side panels 3 and 4 and link bar 2. Place the link bar 2 on the opposite side of the panels so it mirrors the previous assembly.



SMALL COOP RUN Assembly

Step 4: Insert the lower bar into the bottom slot of one of the panel 1 and 2 assemblie. Press down until the lower bar clicks into place. Insert door frame 1 and door frame 2 into the slots on the lower bar with their tabs facing outwards. Insert one of the cross bars into the upper slots of the door frames and then into the top two slots of the side panel

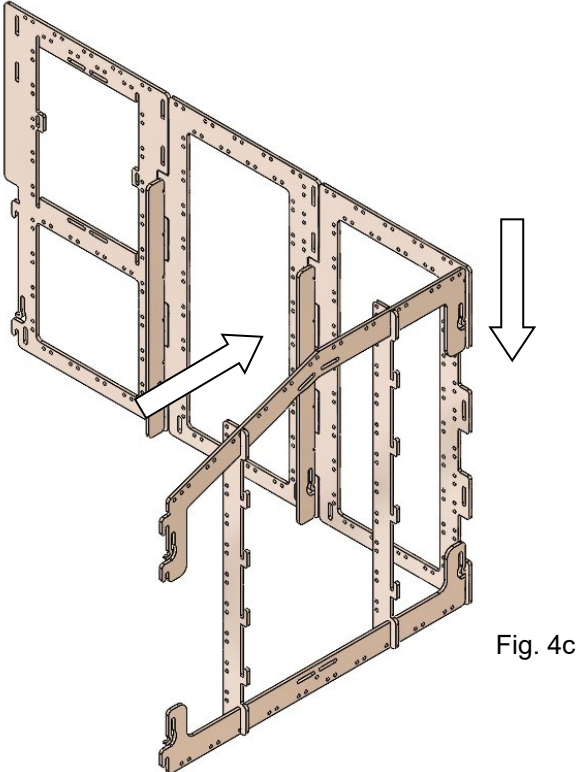
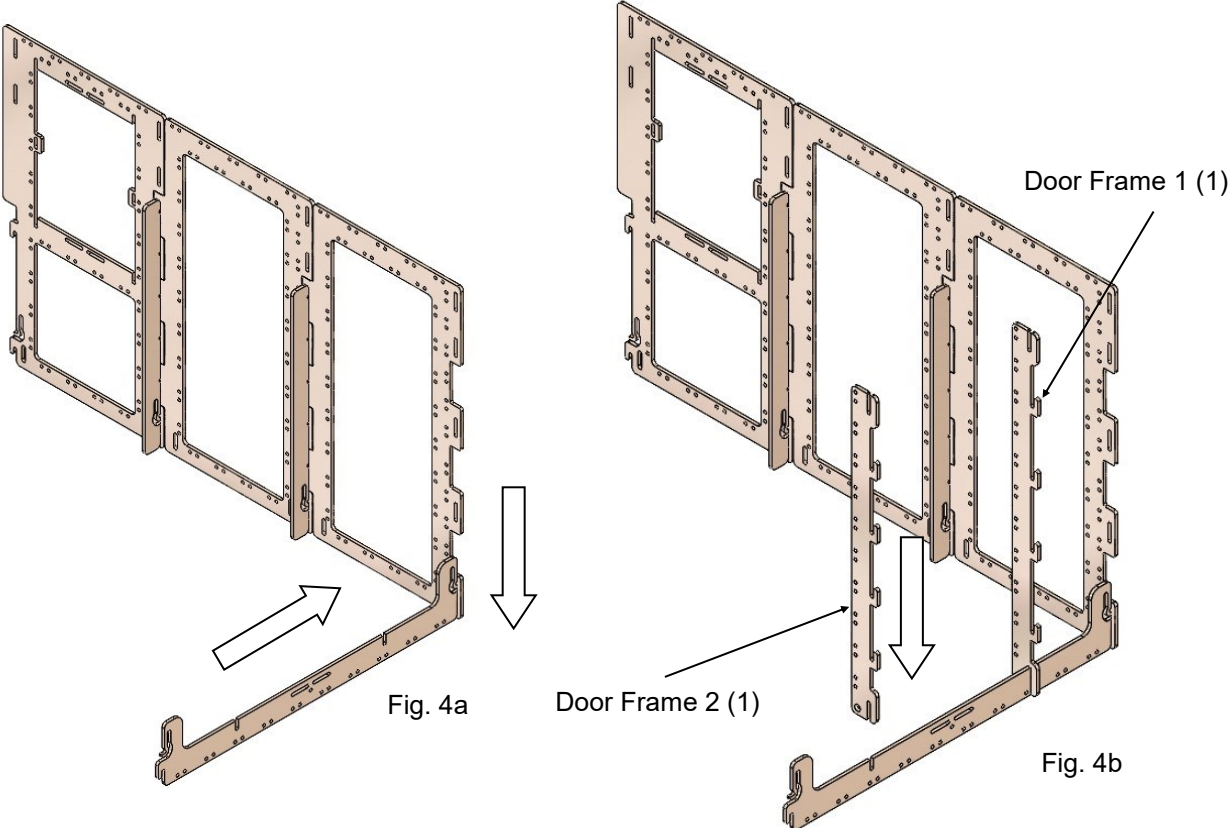

SMALL COOP RUN Assembly

Step 5: Attach the remaining cross bars by inserting them into the top slots of the side panel 1 and 2 assembly and pressing down until they click into place. Then attach side panel 3 and 4 assembly into place and pressing until the crossbars click into place again.

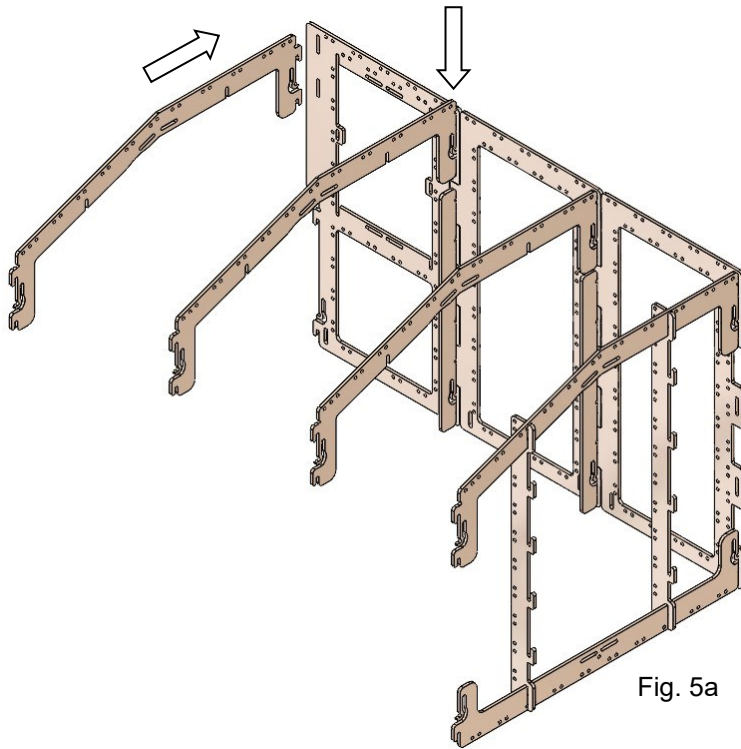

Fig. 5a

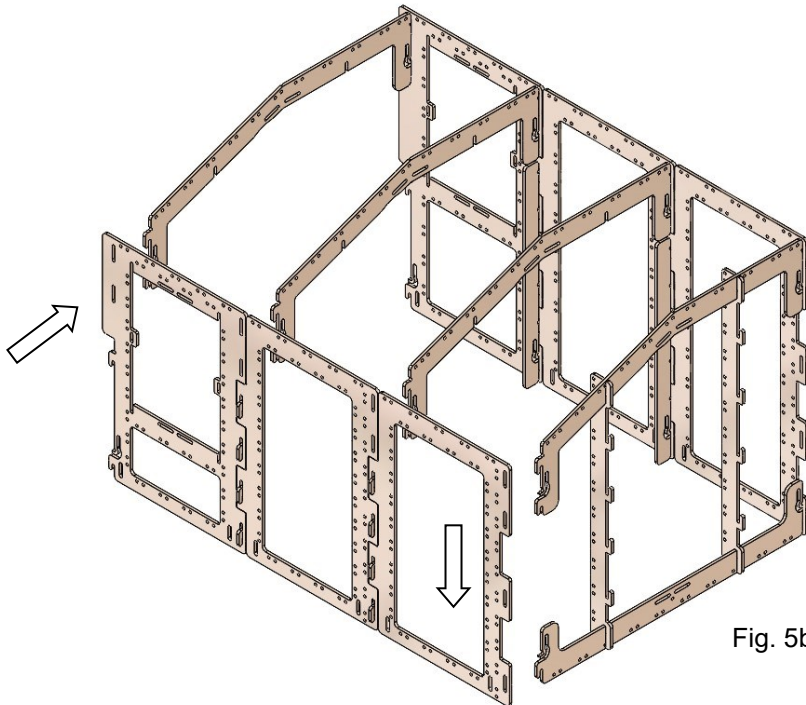

Fig. 5b

SMALL COOP RUN Assembly

Step 6: The side door can be installed either on the left or right of the run assembly. Insert both side door frames into the top opening of the chosen side panel 2 so that the tabs slide into the slots at the four corners and in the middle of each side.

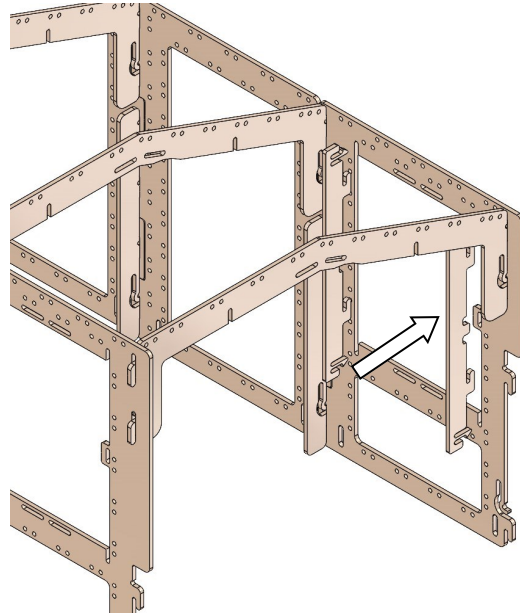
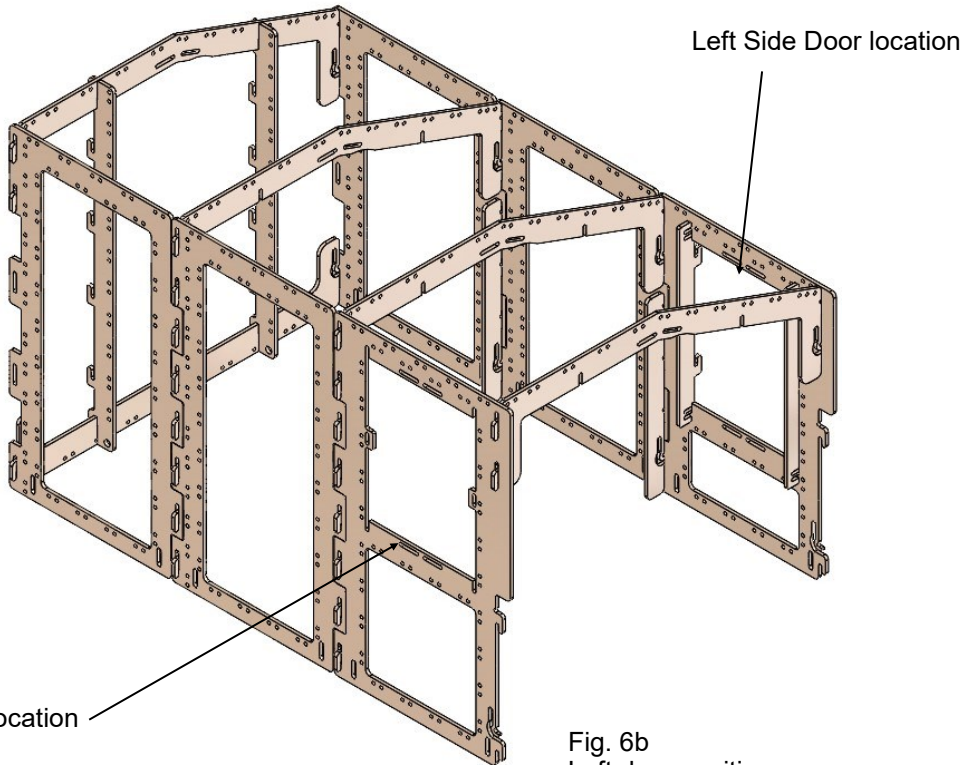

Fig. 6a
Left door position shown



Right Side Door location

Fig. 6b
Left door position
shown

SMALL COOP RUN Assembly

Step 7: Place both the door and side door components in place by inserting the door frame and side door frame tabs into the slots on each door and allowing the door to drop into place. The doors can now be opened by simply lifting the door up and off the chicken coop run.

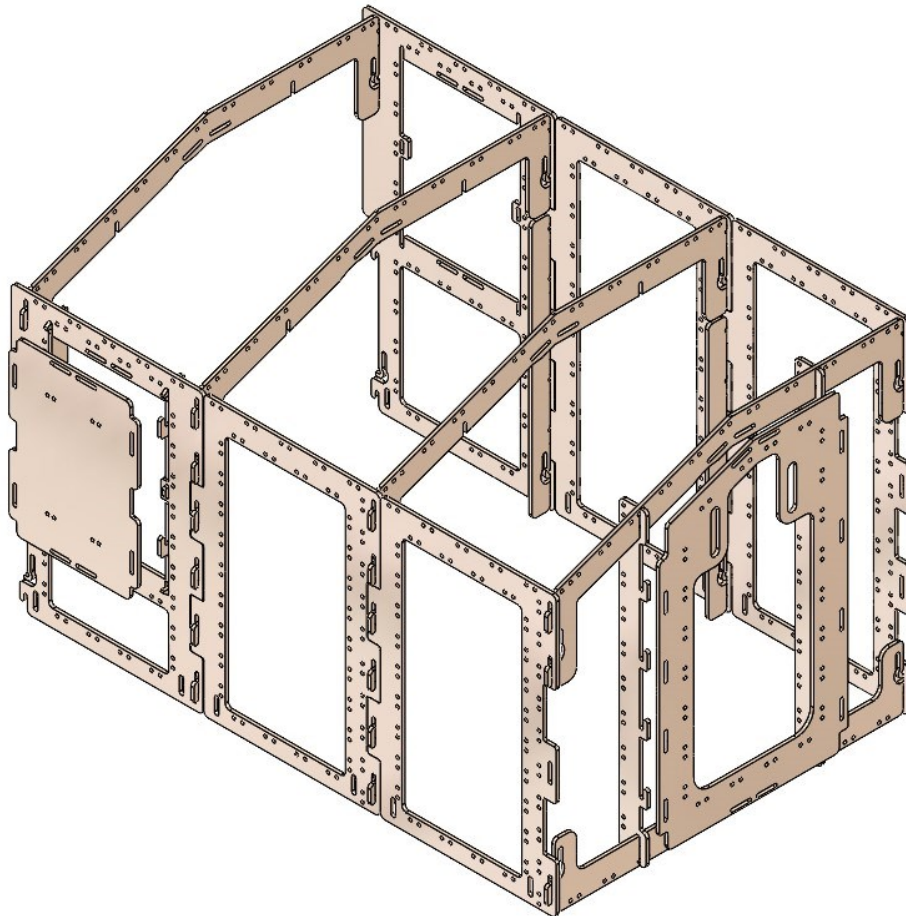

Fig. 7a

SMALL COOP RUN Assembly

Step 8: The Snaplock Small Chicken Coop Run is compatible with all standard chicken wire. Chicken wire is not included with the Snaplock Small Chicken Coop Run.

Cut the chicken wire to the following dimensions and quantities

- 33" x 19" quantity 2
- 38" x 17" quantity 3
- 30" x 17" quantity 3
- 40" x 16" quantity 2
- 34" x 18" quantity 1
- 48" x 21" quantity 3

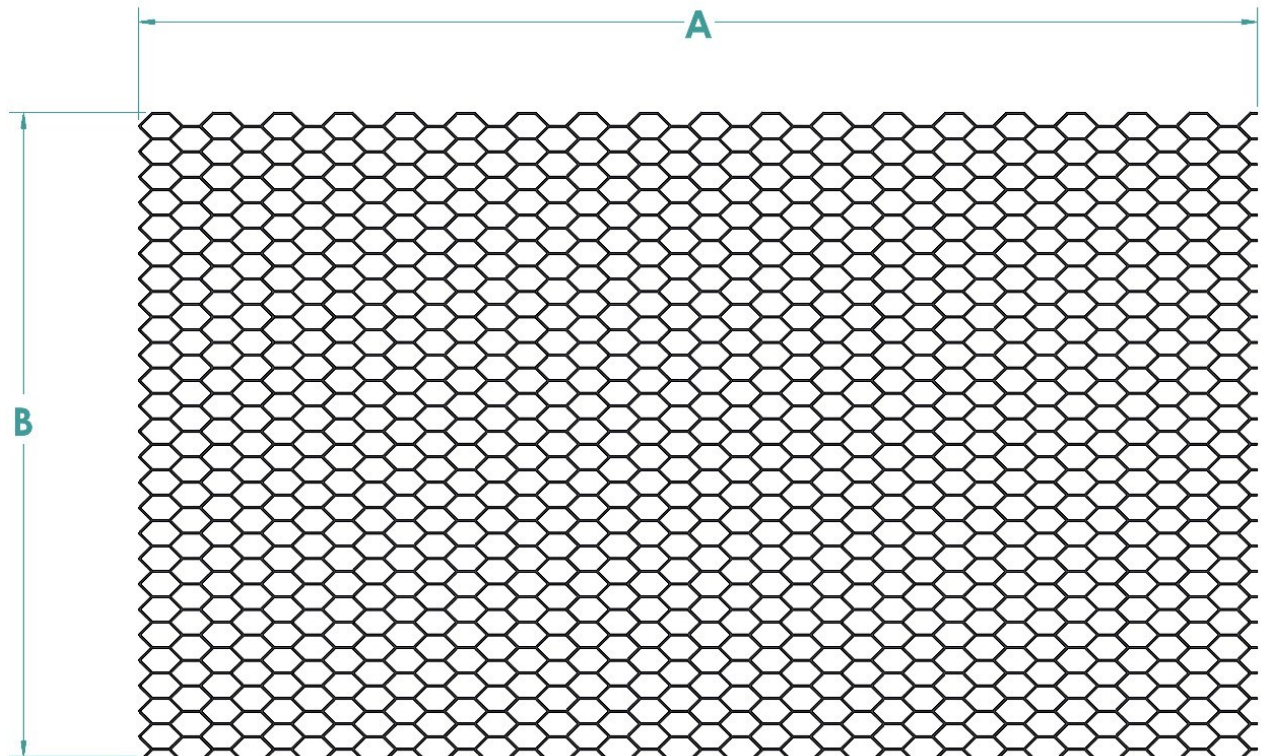

SMALL COOP RUN Assembly

Step 9: Use the any zip tie or wire twist to attach the chicken wire segments to the Small coop run and stand as shown

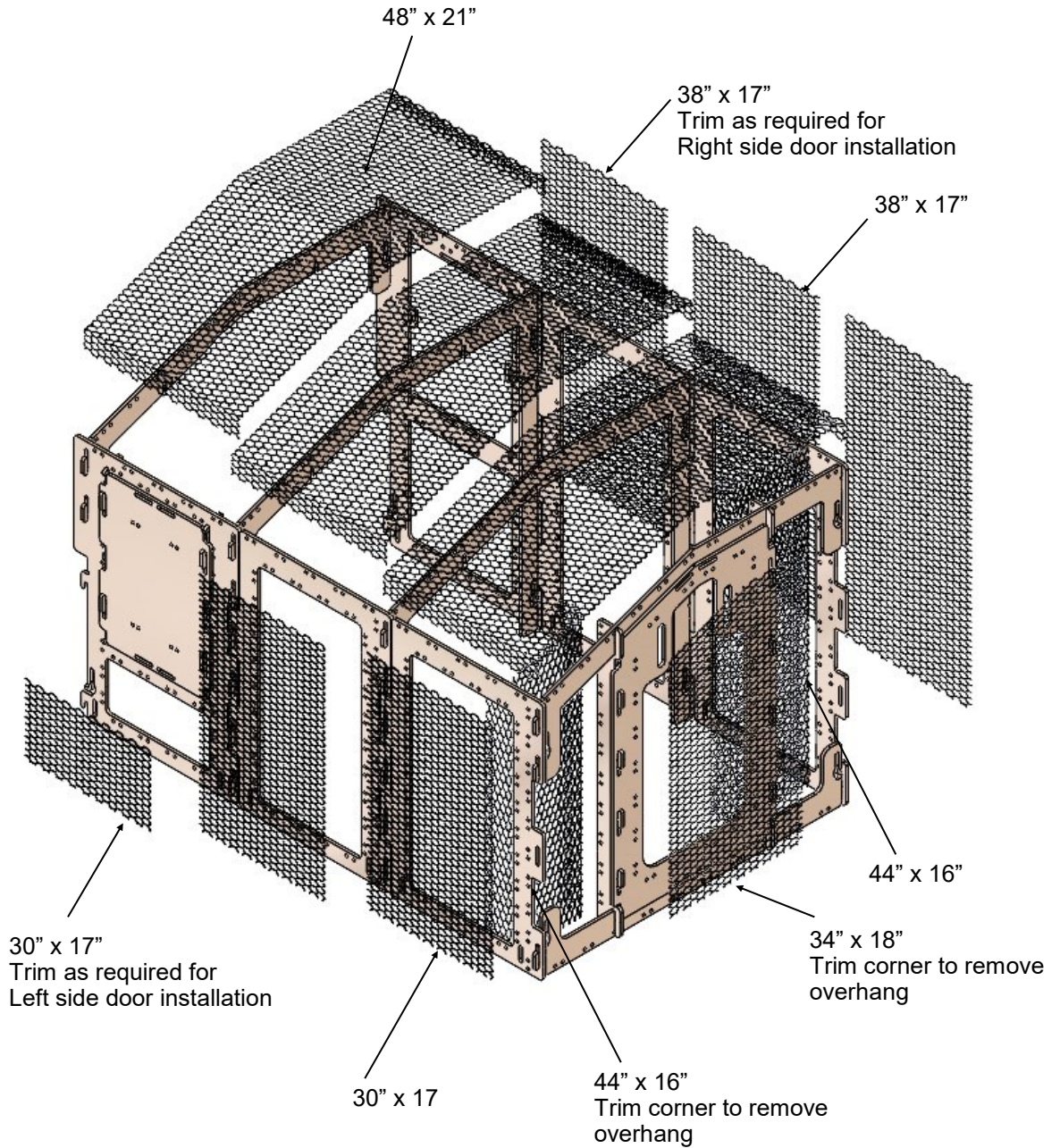
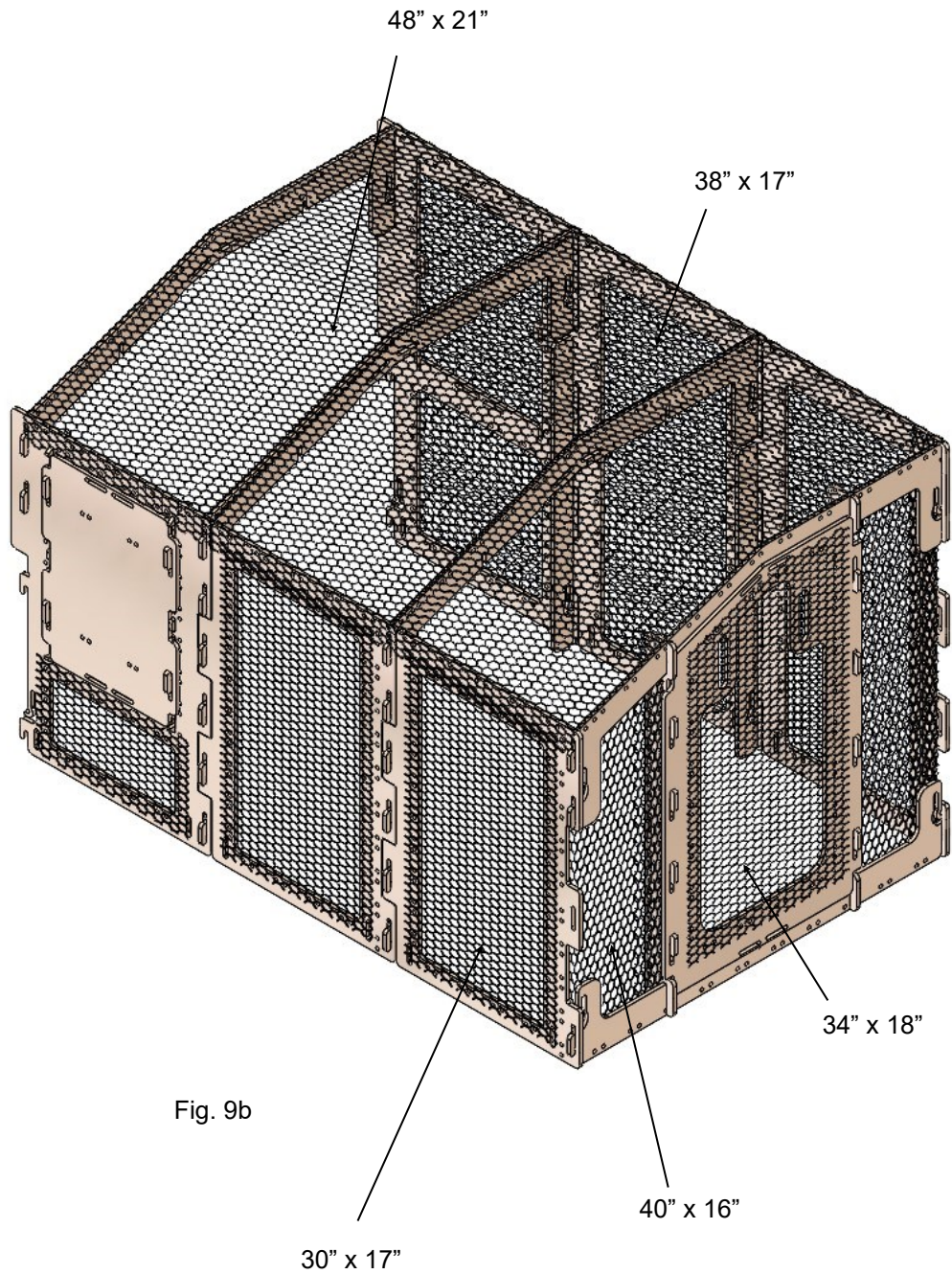

Fig. 9a

SMALL COOP RUN Assembly

Step 9 continued: Use any zip tie or wire twist to attach the chicken wire segments to the Small coop run and stand as shown



SMALL COOP RUN Assembly

Step 10: Attach the Small Chicken Coop Run to the Small Chicken Coop Stand by Inserting the tabs on the lower side of the run into the slots on the coop stand, then press down firmly until the coop run clicks into place

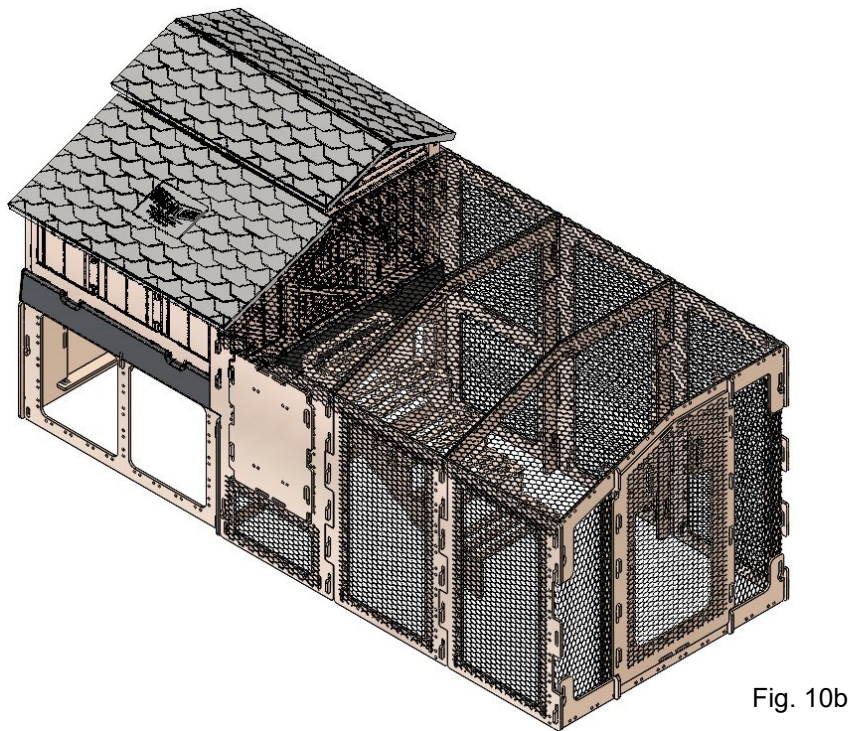
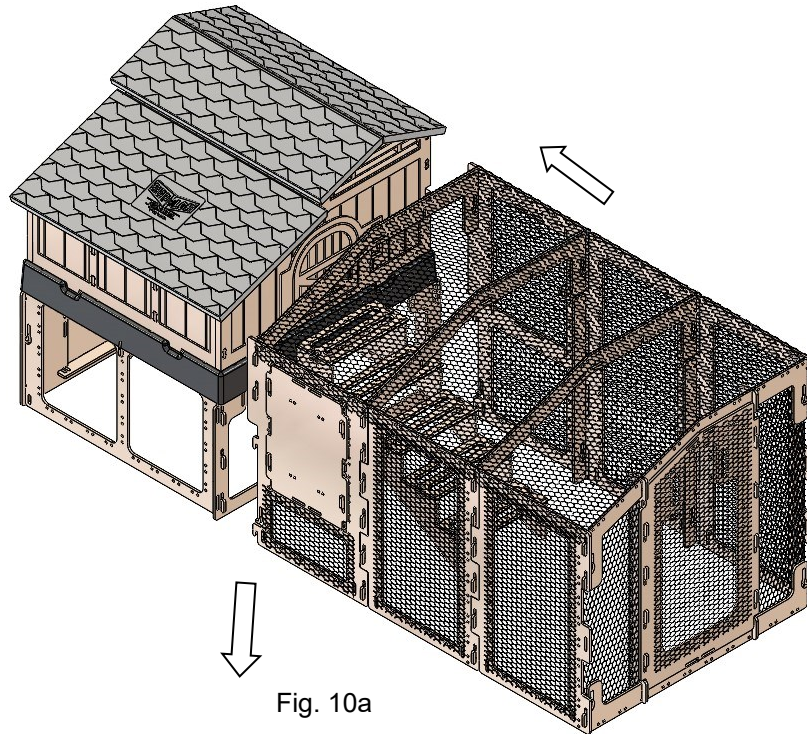

SMALL COOP RUN Assembly

Step 11: Attach the remaining 2 chicken wire pieces to the Small Coop Stand along the exposed sides using any zip tie or wire twist.

